S P E C F I L E

Product Number : PT-**RZ21K**

Product Name : 3-Chip DLP™ Projector

Specifications

Main unit

Power supply		AC 200V-240V, 7.7A, 50/60Hz The light output will decrease to approximately 1/2 when using the projector with AC 100V to AC 120V [9.6A].
Power consumption		1,510 W (1,525 VA [AC200V]) (0.3 W with Standby Mode set to Eco*1, 4 W with Standby Mode set to Normal) 1,217W (Normal Mode), 972 W (Eco Mode) Operating Temperature: 25 °C (77 °F), Altitude: 700m (2,297ft), IEC627087: 2008 Broadcast contents, Picture mode: Standard, Dynamic contrast [2]
BTU value		Max 5,159 BTU
DLP™ chip	Panel size	24.4 mm (0.96 inches) diagonal (16:10 aspect ratio)
	Display method	DLP™ chip × 3, DLP™ projection system
	Pixels	6,912,000 (1920 x 1200 x 3) pixels
Refresh rate		120 Hz*2
Lens		Optional (no lens included with this model), powered zoom, powered focus lens
Light source		Laser Diode (Laser class: Class 1)*Class 3R for North America.
Illumination life of set		Varies depending on operation mode setting. 20,000 hours at half luminance (Normal) 24,000 hours at half luminance (Eco) * IEC62087: 2008 Broadcast contents, Dynamic contrast [3] (NORMAL/ECO Temperature: 30°C (86°F), Altitude 700m (2,297 ft), Dynamic Contrast [3] Under conditions of 0.15 mg/m ³ of particulate matter
Screen size (diagonal)		1.78–25.4 m (70–1,000 in) with 16:10 aspect ratio 1.78–15.24 m (70–600 in) with the ET-D75LE8, 16:10 aspect ratio 3.05–15.24 m (120–600 in) with the ET-D75LE95, 16:10 aspect ratio 21,000 lm (Center)*3*5 / 20,000 lm (Normal)*4*5
Brightness		90 %
Center-to-corner uniformity		20,000:1 (Full On/Full Off, Dynamic Contrast Mode: 3)
Contrast*3		1920 x 1200 pixels
Resolution		fH:15.73KHz fV:59.94Hz, fH:15.63KHz fV:50Hz
Scanning frequency	Video/YC	• Resolution: 640 x 400 pixels to 1920 x 1200 pixels
	RGB	• Dot clock frequency: 162MHz or less
	YPBPR(YCBCR)	• PIAS (Panasonic Intelligent Auto Scanning)
		• Resolution: 480i/576i to 1920 x 1080 pixels
		• Dot clock frequency: 148.5MHz or less
	DVI	• The SYNC/HD and VD terminals do not support 3 value SYNC.
		• Moving image signal resolution: 480i*6/576i*6 to 1920x1080
		Still image signal resolution: 640 x 400 to 1920 x 1200 (non-interlace)
		• Dot clock frequency: 25 MHz to 162 MHz
	HDMI/DIGITAL LINK	• Moving image signal resolution: 480i*6/576i*6 to 1920x1080
		Still image signal resolution: 640 x 400 to 1920 x 1200 (non-interlace)
		• Dot clock frequency: 25 MHz to 162 MHz
	SDI	SD-SDI signal
		HD-SDI signal
		3G-SDI signal
Optical axis shift		Vertical (from center of screen) ±55 % (±44 % with ET-D75LE6, +68 % – +78 % with ET-D75LE95) (powered) Horizontal (from center of screen) ±20 % (±15 % with ET-D75LE6, ±12 % with ET-D75LE95) (powered)

NOTE: Optical axis shift function cannot be operated when used with the ET-D75LE50.

Keystone correction range

Projection lens Model No.	Only [KEystone] used		[KEystone] and [CURVED] used together				Only [CURVED] used	
	Vertical keystone correction angle α (°)	Horizontal keystone correction angle β (°)	Vertical keystone correction angle α (°)	Horizontal keystone correction angle β (°)	Min. value of R2/L2	Min. value of 3/L3	Min. value of R2/L2	Min. value of R3/L3
ET-D75LE6	± 28	± 15	± 10	± 10	1.6	3.9	0.9	2.3
ET-D75LE8	± 40	± 15	± 20	± 15	0.2	0.4	0.2	0.3
ET-D75LE10	± 40	± 15	± 20	± 15	1.1	2.6	0.6	1.5
ET-D75LE20	± 40	± 15	± 20	± 15	0.9	1.7	0.5	1.0
ET-D75LE30	± 40	± 15	± 20	± 15	0.6	1.2	0.4	0.7
ET-D75LE40	± 40	± 15	± 20	± 15	0.4	0.7	0.2	0.4
ET-D75LE50	± 22	± 15	± 8	± 8	2.0	4.9	1.2	2.9
ET-D75LE95*7	+5 / -0	0	-	-	-	-	-	-

When using the optional Upgrade Kit (Model No.: ET-UK20)

Projection lens Model No.	Only [KEystone] used*8		[KEystone] and [CURVED] used together*8				Only [CURVED] used	
	Vertical keystone correction angle α (°)	Horizontal keystone correction angle β (°)	Vertical keystone correction angle α (°)	Horizontal keystone correction angle β (°)	Min. value of R2/L2	Min. value of 3/L3	Min. value of R2/L2	Min. value of R3/L3
ET-D75LE6	± 28	± 15	± 10	± 10	1.2	3.0	0.7	1.7
ET-D75LE8	± 45	± 40	± 20	± 15	0.2	0.3	0.1	0.2
ET-D75LE10	± 40	± 40	± 20	± 15	0.9	2.0	0.5	1.1
ET-D75LE20	± 40	± 40	± 20	± 15	0.7	1.3	0.4	0.7
ET-D75LE30	± 45	± 40	± 20	± 15	0.5	0.9	0.3	0.5
ET-D75LE40	± 45	± 40	± 20	± 15	0.3	0.5	0.2	0.3
ET-D75LE50	± 22	± 15	± 8	± 8	1.5	3.7	0.9	2.2
ET-D75LE95*7	+5 / -0	0	-	-	-	-	-	-

Keystone correction range

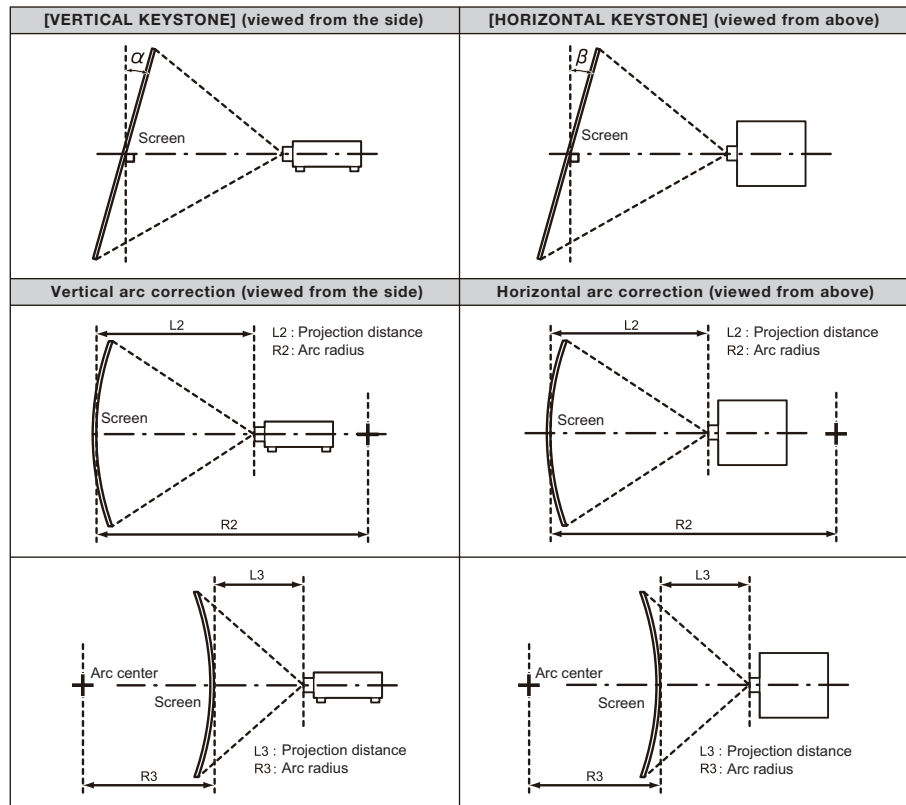

Installation

Terminals

<p>RGB1 IN R,G,B</p> <p>Y, P_B, P_R (Y, C_B, C_R) Y/C</p> <p>VIDEO IN</p> <p>RGB2 IN R,G,B</p> <p>Y, P_B, P_R (Y, C_B, C_R)</p> <p>DVI-D IN</p> <p>HDMI IN</p> <p>SDI IN 1</p> <p>SDI IN 2</p>	<p>Ceiling/floor, front /rear, free 360-degree installation</p> <p>BNC × 5</p> <p>R: 0.7 Vp-p, 75 ohms, G: 0.7 Vp-p (G: 1.0 Vp-p for sync on G), 75 ohms, B: 0.7 Vp-p, 75 ohms</p> <p>HD, VD/SYNC: TTL, high impedance, positive/negative automatic</p> <p>Y: 1.0 Vp-p (including sync signal), P_B/P_R (C_B/C_R): 0.7 Vp-p, 75 ohms</p> <p>Y: 1.0 Vp-p (including sync signal), C: 0.286 Vp-p, 75 ohms</p> <p>BNC × 1, 1.0 Vp-p, 75 ohms</p> <p>D-sub HD 15-pin (female) × 1</p> <p>R: 0.7 Vp-p, 75 ohms, G: 0.7 Vp-p (G: 1.0 Vp-p for sync on G), 75 ohms, B: 0.7 Vp-p, 75 ohms</p> <p>HD, VD/SYNC: TTL, high impedance, positive/negative automatic</p> <p>Y: 1.0 Vp-p (including sync signal), P_B/P_R (C_B/C_R): 0.7 Vp-p, 75 ohms</p> <p>DVI-D 24-pin ×1</p> <p>Single link, DVI 1.0 compliant, HDCP compatible</p> <p>HDMI 19-pin x1</p> <p>HDCP compatible, Deep Color compatible</p> <p>BNC × 1</p> <p>SD-SDI signal SMPTE ST 259 compliant HD-SDI signal SMPTE ST 292 compliant 3G-SDI signal SMPTE ST 424, 425-2 compliant Dual link HD-SDI (LINK A) signal SMPTE ST 372 compliant Dual link 3G-SDI (Link 1) signal SMPTE ST 425-3 compliant</p> <p>BNC × 1</p> <p>SD-SDI signal SMPTE ST 259 compliant HD-SDI signal SMPTE ST 292 compliant 3G-SDI signal SMPTE ST 424, 425-2 compliant Dual link HD-SDI (LINK B) signal SMPTE ST 372 compliant Dual link 3G-SDI (Link 2) signal SMPTE ST 425-3 compliant</p>
--	---

Terminals	DIGITAL LINK	RJ-45	HDBaseT™ compliant, HDCP compatible, Deep Color compatible
	3D SYNC1 IN/OUT /		
	MULTI PROJECTOR SYNC IN	BNC × 1, IN : TTL Hi-z	OUT : TTL max10mA
	3D SYNC2 OUT /		
	MULTI PROJECTOR SYNC OUT	BNC × 1, TTL max10mA	
	SERIAL IN	D-sub 9-pin × 1	for external control (RS-232C compliant)
	SERIAL OUT	D-sub 9-pin × 1	for link control
	REMOTE 1 IN	M3 jack × 1	for wired remote control
	REMOTE 1 OUT	M3 jack × 1	for link control
	REMOTE 2 IN	D-sub 9-pin × 1	for external control (parallel)
	DIGITAL LINK/LAN	RJ-45 × 1	for network connection, 100Base-TX PLink™ (class 2) compatible, Art-Net compatible
	DC OUT 5V	USB connector (type A) × 2	for power supply only (DC 5V, Max 2A)
Power cord length	3.0 m(9 ft 10 in)		
Cabinet materials	Molded plastic		
Dimensions (W × H × D)	598 × 270 × 725 mm (23 17/32" × 10 5/8" × 28 17/32") (not including protruding parts)		
Weight* ⁹	Approximately 49kg (108 lbs) (not including lens)		
Operation noise* ³	46dB		
Operating environment	Operating temperature: 0–50 °C (32–122 °F)* ¹⁰ ; Operating humidity: 10–80 % (no condensation)		

Remote control unit

Power supply	DC 3 V (AAA/R03/LR03 battery × 2)
Operation range	Approx. 30 m (98 ft 5 in) when operated from directly in front of the signal receptor
Dimensions (W × H × D)	47.5 × 181.5 × 27.5 mm (1-7/8" × 7-5/32" × 1-3/32")
Weight	Approx. 150g (5.3 ozs.) (including batteries)

Supplied accessories

- Power cord with secure lock (×2)
- Wireless/wired remote control unit (×1)
- Batteries for remote control (AA/R6 type ×2)
- Lens hole cover (× 1)
- Lens drop-prevention screw (× 1)

Optional accessories

Zoom lens (0.924–1.10:1)	ET-D75LE6	Zoom lens (1.30–1.67:1)	ET-D75LE10
Zoom lens (1.67–2.41:1)	ET-D75LE20	Zoom lens (2.40–4.66:1)	ET-D75LE30
Zoom lens (4.62–7.38:1)	ET-D75LE40	Zoom lens (7.34–13.8:1)	ET-D75LE8
Fixed-focus lens (0.694:1)	ET-D75LE50	Fixed-focus lens (0.364:1)	ET-D75LE95
Ceiling Mount Bracket (for High ceilings)	ET-PKD520H	Ceiling Mount Bracket (for Low ceilings)	ET-PKD520S
Ceiling Mount Bracket (Projector Mount Bracket)	ET-PKD520B		
Stepping Motor kit	ET-D75MKS10	Frame	ET-PFD510
Upgrade kit	ET-UK20	Auto Screen Adjustment Upgrade Kit (PC)	ET-CUK10P
Auto Screen Adjustment Upgrade Kit	ET-CUK10	Lens Fixed Attachment	ET-PLF10
Digital Interface Box	ET-YFB100G	DIGITAL LINK switcher	ET-YFB200G

Compatible Software

- Logo Transfer Software Smart Projector Control (iOS/android)
- Early Warning Software (Basic license/3-year license) (ET-SWA100series*) *The suffix of the Model No. differs according to the license type.

*1 When Standby Mode is set to ECO, network functions such as power on over LAN will not operate. Additionally, only certain commands can be received for external control using the serial terminal.
 *2 Refresh rate varies depending on scanning frequency.
 *3 Measurement, measuring conditions, and method of notation all comply with ISO 21118 international standards.
 *4 The value of the light output at the center region of the projected image is extracted based on the light output measurement method defined by the ISO/IEC 21118:2012 international standards.
 *5 In AC200V, When using a projection lens other than ET-D75LE95.
 *6 Pixel-Repetition signal(dot clock frequency 27.0MHz) only
 *7 Only the vertical keystone correction angle can be corrected in the direction in which the projector body moves away from the screen.
 *8 When [VERTICAL KEYSTONE] and [HORIZONTAL KEYSTONE] are used simultaneously, correction cannot be made exceeding total of 55°.
 *9 Average value. May differ depending on the actual unit.
 *10 Operating temperature is 0–45 °C (32–113 °F) when used in locations from 1,400 m to 4,200 m (4,593 ft to 13,779 ft) above sea level.
 When the [PROJECTOR SETUP] menu → [OPERATION SETTING] → [OPERATING MODE] is set to [NORMAL], and the operating environment temperature exceeds the following value, the light output may be reduced to protect the projector.
 •When using the projector at an altitude lower than 2,700m (8,858') above sea level: 35°C (95°F)
 •When using the projector at an altitude between 2,700m (8,858') and 4,200m (13,780') above sea level: 25°C (77°F)

Dimensions

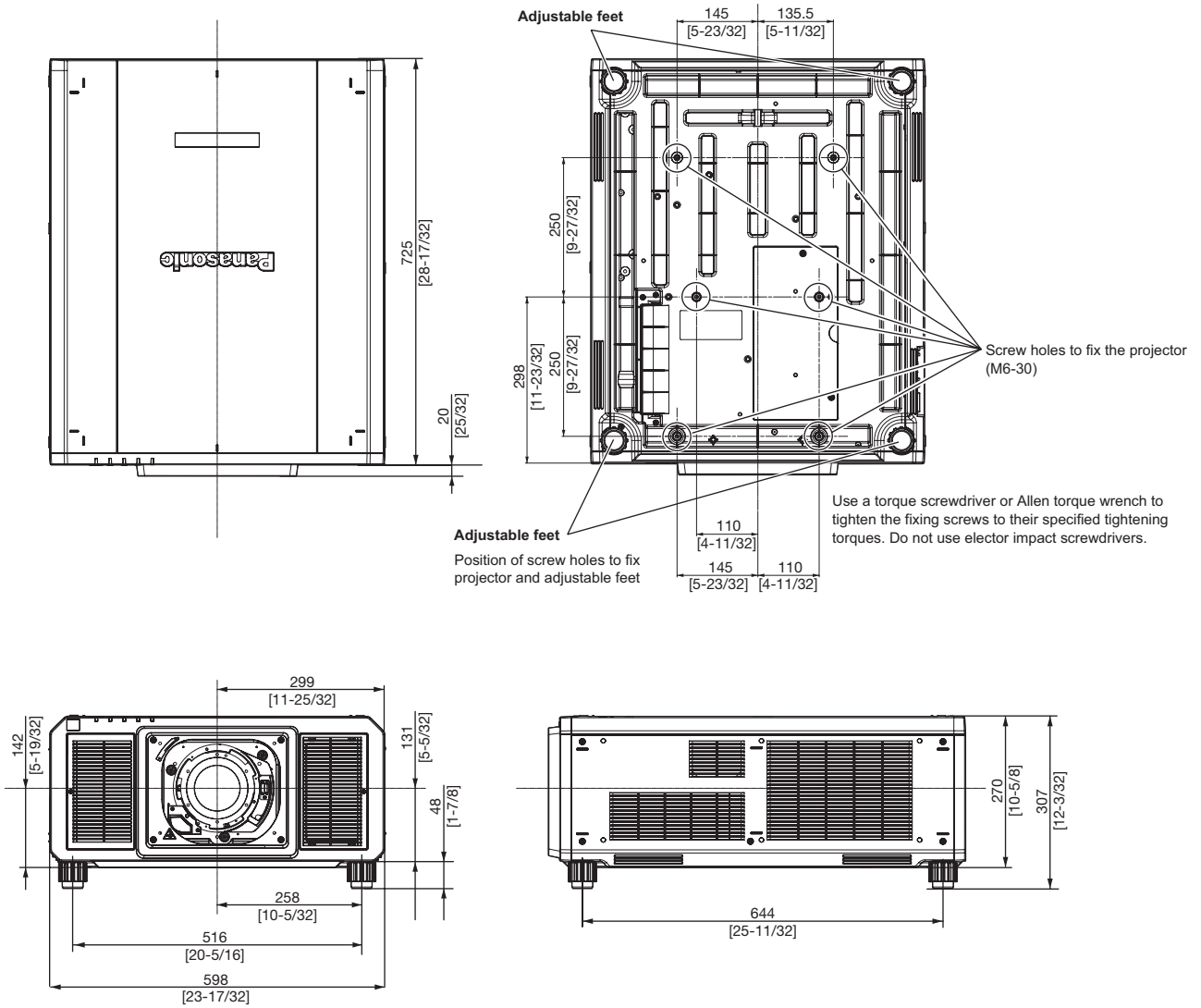

unit : mm (inch)
NOTE: This illustration is not drawn to scale.

Terminals

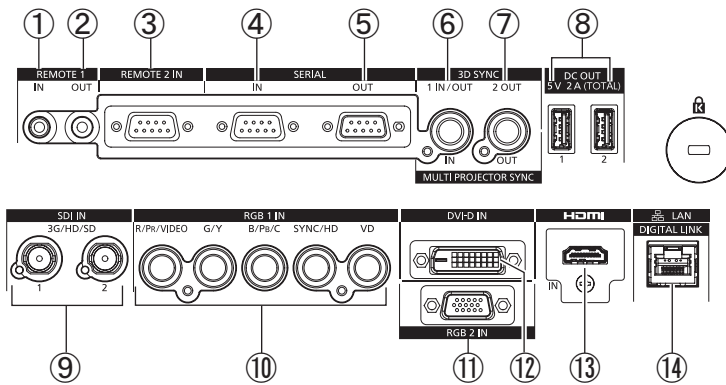

- 1 Remote 1 input
- 2 Remote 1 output
- 3 Remote 2 input
- 4 Serial input
- 5 Serial output
- 6 MULTI PROJECTOR SYNC IN
3D SYNC 1 IN/OUT
- 7 MULTI PROJECTOR SYNC OUT
3D SYNC 2 OUT
- 8 DC output 1/DC output 2
- 9 SDI 1 input/SDI 2 input
- 10 RGB 1 input
- 11 RGB 2 Input
- 12 DVI-D input
- 13 HDMI input
- 14 LAN/DIGITAL LINK connector

Power cord

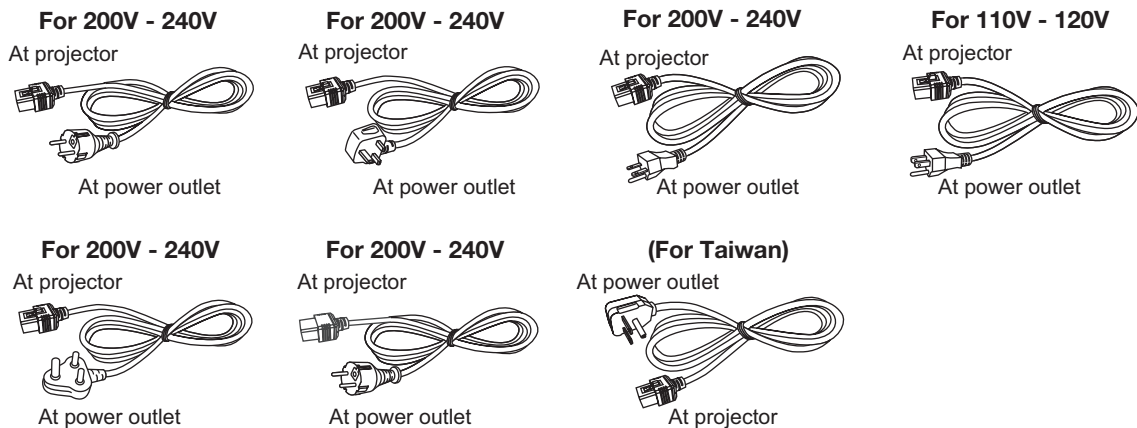

At projector

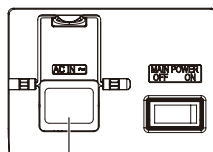

AC IN terminal

Power outlets that can be used



2P/3W 15 A 250 V



2P/3W 15 A 250 V

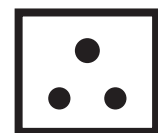

2P/3W 15 A 250 V



2P/3W 15 A 250 V



2P/3W 15 A 125 V

This projector supports AC100 V to AC120 V, and AC 200 V to AC 240 V as the power supply. A grounding outlet supporting 15 A is required with either voltage.

The shape of the usable outlet differs depending on the power supply. Following illustrations are examples.

Standard setting-up position

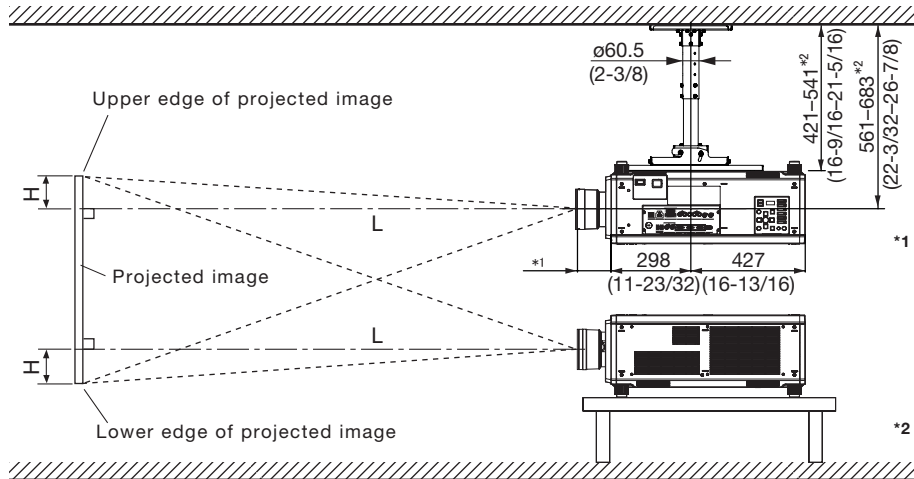

unit : mm (inch)

Illustrations show the projector installed using optional ceiling mount bracket ET-PKD520H/ET-PKD520B.

*1 When the lens protrudes to the maximum.

- 212 mm (8-11/32) with the ET-D75LE6
- 125 mm (4-29/32) with the ET-D75LE10
- 121 mm (4-3/4) with the ET-D75LE20
- 121 mm (4-3/4) with the ET-D75LE30
- 124 mm (4-7/8) with the ET-D75LE40
- 254 mm (10) with the ET-D75LE8
- 203 mm (8) with the ET-D75LE50

*2 Adjustable in 40 mm (1-9/16 in) steps.

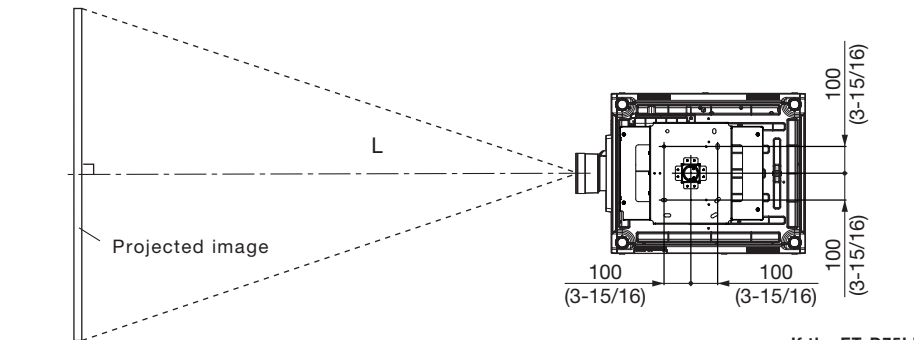

This illustration is not drawn to scale.

If the ET-D75LE95 is attached, refer to the projection system dimension drawing and the projection distance table for ET-D75LE95 specifications.

Caution:

- All construction work should be done by a qualified technician.

Projection distance for 16:10 aspect ratio screen

(ET-D75LE6/D75LE10/D75LE20/D75LE30/D75LE40/D75LE8/D75LE50)

Unit: meters

Screen size (diagonal)	Distance to screen (L)												Height from the edge of screen to center of lens (H)					
	Zoom												Fixed-focus					
	ET-D75LE6 Zoom lens		ET-D75LE10 Zoom lens		ET-D75LE20 Zoom lens		ET-D75LE30 Zoom lens		ET-D75LE40 Zoom lens		ET-D75LE8 Zoom lens		ET-D75LE50 Fixed-focus lens		Zoom lenses Except ET-D75LE6		Fixed- focus lens	
[m] / [in]	min.	max.	min.	max.	min.	max.	min.	max.	min.	max.	min.	max.	min.	max.	min.	max.	min.	max.
1.78 / 70	1.36	1.63	1.90	2.46	2.46	3.58	3.56	6.94	6.87	11.04	10.85	20.69	1.01	-0.047-	0.989	0.057-	0.886	0.47
2.03 / 80	1.56	1.87	2.19	2.83	2.82	4.11	4.08	7.96	7.88	12.65	12.45	23.70	1.16	-0.054-	1.131	0.065-	1.012	0.54
2.29 / 90	1.77	2.11	2.47	3.20	3.19	4.64	4.61	8.98	8.88	14.25	14.06	26.71	1.32	-0.061-	1.272	0.073-	1.139	0.61
2.54 / 100	1.97	2.35	2.76	3.56	3.55	5.17	5.13	9.99	9.88	15.85	15.66	29.71	1.47	-0.067-	1.414	0.081-	1.265	0.67
3.05 / 120	2.38	2.84	3.32	4.30	4.28	6.22	6.18	12.03	11.89	19.05	18.88	35.73	1.78	-0.081-	1.696	0.097-	1.519	0.81
3.81 / 150	2.98	3.57	4.18	5.40	5.37	7.81	7.75	15.08	14.90	23.85	23.69	44.75	2.24	-0.101-	2.120	0.121-	1.898	1.01
5.08 / 200	4.00	4.78	5.60	7.24	7.19	10.45	10.38	20.16	19.92	31.86	31.72	59.79	3.01	-0.135-	2.827	0.162-	2.531	1.35
6.35 / 250	5.01	6.00	7.02	9.07	9.00	13.09	13.00	25.25	24.95	39.86	39.74	74.82	3.78	-0.168-	3.534	0.202-	3.164	1.68
7.62 / 300	6.02	7.21	8.44	10.91	10.82	15.73	15.62	30.34	29.97	47.87	47.77	89.86	4.56	-0.202-	4.241	0.242-	3.796	2.02
8.89 / 350	7.04	8.42	9.86	12.74	12.64	18.37	18.24	35.42	34.99	55.87	55.79	104.90	5.33	-0.236-	4.947	0.283-	4.429	2.36
10.16 / 400	8.05	9.64	11.28	14.58	14.46	21.01	20.86	40.51	40.01	63.87	63.82	119.94	6.10	-0.269-	5.654	0.323-	5.062	2.69
12.70 / 500	10.08	12.07	14.12	18.25	18.09	26.29	26.11	50.68	50.05	79.88	79.87	150.01	7.64	-0.337-	7.068	0.404-	6.327	3.37
15.24 / 600	12.10	14.49	16.96	21.92	21.73	31.58	31.35	60.85	60.09	95.89	95.92	180.08	9.18	-0.404-	8.481	0.485-	7.593	4.04
17.78 / 700	14.13	16.92	19.80	25.60	25.36	36.86	36.60	71.02	70.13	111.90	111.97	-	10.72	-0.471-	9.895	0.565-	8.858	4.71
20.32 / 800	16.16	19.35	22.64	29.27	29.00	42.14	41.84	81.19	80.17	127.91	128.02	-	12.27	-0.538-	11.308	0.646-	10.123	5.39
22.86 / 900	18.18	21.78	25.48	32.94	32.63	47.42	47.09	91.36	90.21	143.92	144.07	-	13.81	-0.606-	12.722	0.727-	11.389	6.06
25.40 / 1000	20.21	24.21	28.33	36.61	36.27	52.70	52.33	101.53	100.25	159.93	160.13	-	15.35	-0.673-	14.135	0.808-	12.654	6.73

Unit: feet

Screen size (diagonal)	Distance to screen (L)												Height from the edge of screen to center of lens (H)					
	Zoom												Fixed-focus					
	ET-D75LE6 Zoom lens		ET-D75LE10 Zoom lens		ET-D75LE20 Zoom lens		ET-D75LE30 Zoom lens		ET-D75LE40 Zoom lens		ET-D75LE8 Zoom lens		ET-D75LE50 Fixed-focus lens		Zoom lenses Except ET-D75LE6		Fixed- focus lens	
[m] / [in]	min.	max.	min.	max.	min.	max.	min.	max.	min.	max.	min.	max.	min.	max.	min.	max.	min.	max.
1.78 / 70	4.5	5.3	6.2	8.1	8.1	11.7	11.7	22.8	22.5	36.2	35.6	67.9	3.3	-0.2-	3.2	0.2-	2.9	1.5
2.03 / 80	5.1	6.1	7.2	9.3	9.3	13.5	13.4	26.1	25.9	41.5	40.8	77.8	3.8	-0.2-	3.7	0.2-	3.3	1.8
2.29 / 90	5.8	6.9	8.1	10.5	10.5	15.2	15.1	29.5	29.1	46.8	46.1	87.6	4.3	-0.2-	4.2	0.2-	3.7	2.0
2.54 / 100	6.5	7.7	9.1	11.7	11.6	17.0	16.8	32.8	32.4	52.0	51.4	97.5	4.8	-0.2-	4.6	0.3-	4.2	2.2
3.05 / 120	7.8	9.3	10.9	14.1	14.0	20.4	20.3	39.5	39.0	62.5	61.9	117.2	5.8	-0.3-	5.6	0.3-	5.0	2.6
3.81 / 150	9.8	11.7	13.7	17.7	17.6	25.6	25.4	49.5	48.9	78.2	77.7	146.8	7.3	-0.3-	7.0	0.4-	6.2	3.3
5.08 / 200	13.1	15.7	18.4	23.8	23.6	34.3	34.1	66.1	65.4	104.5	104.1	196.2	9.9	-0.4-	9.3	0.5-	8.3	4.4
6.35 / 250	16.4	19.7	23.0	29.8	29.5	42.9	42.7	82.8	81.9	130.8	130.4	245.5	12.4	-0.6-	11.6	0.7-	10.4	5.5
7.62 / 300	19.8	23.7	27.7	35.8	35.5	51.6	51.2	99.5	98.3	157.1	156.7	294.8	15.0	-0.7-	13.9	0.8-	12.5	6.6
8.89 / 350	23.1	27.6	32.3	41.8	41.5	60.3	59.8	116.2	114.8	183.3	183.0	344.2	17.5	-0.8-	16.2	0.9-	14.5	7.7
10.16 / 400	26.4	31.6	37.0	47.8	47.4	68.9	68.4	132.9	131.3	209.5	209.4	393.5	20.0	-0.9-	18.5	1.1-	16.6	8.8
12.70 / 500	33.1	39.6	46.3	59.9	59.4	86.3	85.7	166.3	164.2	262.1	262.0	492.2	25.1	-1.1-	23.2	1.3-	20.8	11.0
15.24 / 600	39.7	47.5	55.6	71.9	71.3	103.6	102.9	199.6	197.1	314.6	314.7	590.8	30.1	-1.3-	27.8	1.6-	24.9	13.2
17.78 / 700	46.4	55.5	65.0	84.0	83.2	120.9	120.1	233.0	230.1	367.1	367.4	-	35.2	-1.5-	32.5	1.9-	29.1	15.5
20.32 / 800	53.0	63.5	74.3	96.0	95.1	138.3	137.3	266.4	263.0	419.7	420.0	-	40.3	-1.8-	37.1	2.1-	33.2	17.7
22.86 / 900	59.6	71.5	83.6	108.1	107.1	155.6	154.5	299.7	296.0	472.2	472.7	-	45.3	-2.0-	41.7	2.4-	37.4	19.9
25.40 / 1000	66.3	79.4	92.9	120.1	119.0	172.9	171.7	333.1	328.9	524.7	525.4	-	50.4	-2.2-	46.4	2.7-	41.5	22.1

- The value for L (distance to screen) varies slightly within ±5% depending on the zoom lens characteristics.
- At the shortest projection distance, the zoom lens characteristics may cause slight image distortion.
- When vertical keystone correction is used, the image is corrected in the direction that reduces its projected size.

NOTE: When the ET-D75LE50 is mounted, the optical lens shift function cannot be used.

Projection distance for 16:9 aspect ratio screen

(ET-D75LE6/D75LE10/D75LE20/D75LE30/D75LE40/D75LE8/D75LE50)

Unit: meters

Screen size (diagonal)	Distance to screen (L)												Height from the edge of screen to center of lens (H)					
	Zoom												Fixed-focus					
	ET-D75LE6 Zoom lens		ET-D75LE10 Zoom lens		ET-D75LE20 Zoom lens		ET-D75LE30 Zoom lens		ET-D75LE40 Zoom lens		ET-D75LE8 Zoom lens		ET-D75LE50 Fixed-focus lens	Zoom lenses Except ET-D75LE6		Fixed- focus lens		
[m] / [in]	min.	max.	min.	max.	min.	max.	min.	max.	min.	max.	min.	max.	min.	max.	min.	max.	min.	max.
1.78 / 70	1.40	1.67	1.96	2.53	2.53	3.68	3.66	7.14	7.07	11.36	11.16	21.28	1.04	-0.087	0.959	0	0.872	0.44
2.03 / 80	1.61	1.92	2.25	2.91	2.91	4.23	4.20	8.19	8.10	13.00	12.81	24.37	1.20	-0.100	1.096	0	0.996	0.50
2.29 / 90	1.82	2.17	2.54	3.29	3.28	4.77	4.74	9.23	9.13	14.65	14.46	27.46	1.36	-0.112	1.233	0	1.121	0.56
2.54 / 100	2.03	2.42	2.83	3.67	3.65	5.31	5.28	10.28	10.16	16.29	16.11	30.55	1.51	-0.125	1.370	0	1.245	0.62
3.05 / 120	2.44	2.92	3.42	4.42	4.40	6.40	6.35	12.37	12.23	19.58	19.41	36.73	1.83	-0.149	1.644	0	1.494	0.75
3.81 / 150	3.07	3.67	4.29	5.55	5.52	8.03	7.97	15.50	15.32	24.52	24.36	46.00	2.31	-0.187	2.055	0	1.868	0.93
5.08 / 200	4.11	4.92	5.75	7.44	7.39	10.74	10.67	20.73	20.48	32.75	32.61	61.46	3.10	-0.249	2.740	0	2.491	1.25
6.35 / 250	5.15	6.17	7.21	9.33	9.26	13.46	13.36	25.96	25.64	40.97	40.86	76.91	3.89	-0.311	3.424	0	3.113	1.56
7.62 / 300	6.19	7.41	8.67	11.21	11.13	16.17	16.06	31.18	30.80	49.20	49.11	92.37	4.68	-0.374	4.109	0	3.736	1.87
8.89 / 350	7.23	8.66	10.13	13.10	12.99	18.88	18.75	36.41	35.96	57.43	57.35	107.82	5.48	-0.436	4.794	0	4.358	2.18
10.16 / 400	8.28	9.91	11.59	14.99	14.86	21.60	21.45	41.64	41.12	65.65	65.60	123.28	6.27	-0.498	5.479	0	4.981	2.49
12.70 / 500	10.36	12.40	14.51	18.76	18.60	27.03	26.84	52.09	51.44	82.11	82.10	154.19	7.85	-0.623	6.849	0	6.226	3.11
15.24 / 600	12.44	14.90	17.44	22.54	22.33	32.46	32.23	62.54	61.76	98.56	98.60	185.10	9.44	-0.747	8.219	0	7.472	3.74
17.78 / 700	14.52	17.39	20.36	26.31	26.07	37.89	37.62	73.00	72.08	115.02	115.10	-	11.02	-0.872	9.589	0	8.717	4.36
20.32 / 800	16.61	19.89	23.28	30.09	29.81	43.31	43.01	83.45	82.41	131.47	131.59	-	12.61	-0.996	10.958	0	9.962	4.98
22.86 / 900	18.69	22.39	26.20	33.86	33.54	48.74	48.40	93.90	92.73	147.92	148.09	-	14.19	-1.121	12.328	0	11.207	5.60
25.40 / 1000	20.77	24.88	29.12	37.63	37.28	54.17	53.79	104.36	103.05	164.38	164.59	-	15.78	-1.245	13.698	0	12.453	6.23

Unit: feet

Screen size (diagonal)	Distance to screen (L)												Height from the edge of screen to center of lens (H)					
	Zoom												Fixed-focus					
	ET-D75LE6 Zoom lens		ET-D75LE10 Zoom lens		ET-D75LE20 Zoom lens		ET-D75LE30 Zoom lens		ET-D75LE40 Zoom lens		ET-D75LE8 Zoom lens		ET-D75LE50 Fixed-focus lens	Zoom lenses Except ET-D75LE6		Fixed- focus lens		
[m] / [in]	min.	max.	min.	max.	min.	max.	min.	max.	min.	max.	min.	max.	min.	max.	min.	max.	min.	max.
1.78 / 70	4.6	5.5	6.4	8.3	8.3	12.1	12.0	23.4	23.2	37.3	36.6	69.8	3.4	-0.3	3.1	0	2.9	1.4
2.03 / 80	5.3	6.3	7.4	9.5	9.5	13.9	13.8	26.9	26.6	42.7	42.0	80.0	3.9	-0.3	3.6	0	3.3	1.6
2.29 / 90	6.0	7.1	8.3	10.8	10.8	15.6	15.6	30.3	30.0	48.1	47.4	90.1	4.5	-0.4	4.0	0	3.7	1.8
2.54 / 100	6.7	7.9	9.3	12.0	12.0	17.4	17.3	33.7	33.3	53.4	52.9	100.2	5.0	-0.4	4.5	0	4.1	2.0
3.05 / 120	8.0	9.6	11.2	14.5	14.4	21.0	20.8	40.6	40.1	64.2	63.7	120.5	6.0	-0.5	5.4	0	4.9	2.5
3.81 / 150	10.1	12.0	14.1	18.2	18.1	26.3	26.1	50.9	50.3	80.4	79.9	150.9	7.6	-0.6	6.7	0	6.1	3.1
5.08 / 200	13.5	16.1	18.9	24.4	24.2	35.2	35.0	68.0	67.2	107.4	107.0	201.6	10.2	-0.8	9.0	0	8.2	4.1
6.35 / 250	16.9	20.2	23.7	30.6	30.4	44.2	43.8	85.2	84.1	134.4	134.1	252.3	12.8	-1.0	11.2	0	10.2	5.1
7.62 / 300	20.3	24.3	28.4	36.8	36.5	53.1	52.7	102.3	101.0	161.4	161.1	303.1	15.4	-1.2	13.5	0	12.3	6.1
8.89 / 350	23.7	28.4	33.2	43.0	42.6	61.9	61.5	119.5	118.0	188.4	188.2	353.7	18.0	-1.4	15.7	0	14.3	7.1
10.16 / 400	27.2	32.5	38.0	49.2	48.8	70.9	70.4	136.6	134.9	215.4	215.2	404.5	20.6	-1.6	18.0	0	16.3	8.2
12.70 / 500	34.0	40.7	47.6	61.5	61.0	88.7	88.1	170.9	168.8	269.4	269.4	505.9	25.8	-2.0	22.5	0	20.4	10.2
15.24 / 600	40.8	48.9	57.2	74.0	73.3	106.5	105.7	205.2	202.6	323.4	323.5	607.3	31.0	-2.5	27.0	0	24.5	12.3
17.78 / 700	47.6	57.1	66.8	86.3	85.5	124.3	123.4	239.5	236.5	377.4	377.6	-	36.2	-2.9	31.5	0	28.6	14.3
20.32 / 800	54.5	65.3	76.4	98.7	97.8	142.1	141.1	273.8	270.4	431.3	431.7	-	41.4	-3.3	36.0	0	32.7	16.3
22.86 / 900	61.3	73.5	86.0	111.1	110.0	159.9	158.8	308.1	304.2	485.3	485.9	-	46.6	-3.7	40.4	0	36.8	18.4
25.40 / 1000	68.1	81.6	95.5	123.5	122.3	177.7	176.5	342.4	338.1	539.3	540.0	-	51.8	-4.1	44.9	0	40.9	20.4

- The value for L (distance to screen) varies slightly within ±5% depending on the zoom lens characteristics.
- At the shortest projection distance, the zoom lens characteristics may cause slight image distortion.
- When vertical keystone correction is used, the image is corrected in the direction that reduces its projected size.

NOTE: When the ET-D75LE50 is mounted, the optical lens shift function cannot be used.

Projection distance for 4:3 aspect ratio screen

(ET-D75LE6/D75LE10/D75LE20/D75LE30/D75LE40/D75LE8/D75LE50)

Unit: meters

Screen size (diagonal)	Distance to screen (L)												Height from the edge of screen to center of lens (H)			
	Zoom												Fixed-focus			
	ET-D75LE6 Zoom lens		ET-D75LE10 Zoom lens		ET-D75LE20 Zoom lens		ET-D75LE30 Zoom lens		ET-D75LE40 Zoom lens		ET-D75LE8 Zoom lens		ET-D75LE50 Fixed-focus lens	Zoom lenses Except ET-D75LE6		Fixed- focus lens
[m] / [in]	min.	max.	min.	max.	min.	max.	min.	max.	min.	max.	min.	max.				
1.78 / 70	1.55	1.85	2.17	2.80	2.80	4.07	4.04	7.88	7.80	12.52	12.33	23.47	1.15	0 – 1.067	0.107 – 0.960	0.53
2.03 / 80	1.78	2.13	2.49	3.22	3.21	4.67	4.64	9.03	8.94	14.34	14.15	26.88	1.33	0 – 1.219	0.122 – 1.097	0.61
2.29 / 90	2.01	2.40	2.81	3.63	3.62	5.27	5.23	10.19	10.07	16.15	15.97	30.28	1.50	0 – 1.372	0.137 – 1.234	0.69
2.54 / 100	2.24	2.68	3.13	4.05	4.03	5.86	5.82	11.34	11.21	17.96	17.78	33.69	1.67	0 – 1.524	0.152 – 1.372	0.76
3.05 / 120	2.70	3.22	3.77	4.88	4.86	7.06	7.01	13.64	13.48	21.59	21.42	40.50	2.02	0 – 1.829	0.183 – 1.646	0.91
3.81 / 150	3.38	4.05	4.74	6.13	6.09	8.85	8.79	17.09	16.89	27.02	26.87	50.71	2.55	0 – 2.286	0.229 – 2.057	1.14
5.08 / 200	4.53	5.42	6.35	8.21	8.15	11.84	11.76	22.85	22.58	36.09	35.96	67.73	3.42	0 – 3.048	0.305 – 2.743	1.52
6.35 / 250	5.68	6.80	7.96	10.28	10.20	14.83	14.73	28.61	28.26	45.15	45.04	84.75	4.29	0 – 3.810	0.381 – 3.429	1.91
7.62 / 300	6.83	8.17	9.56	12.36	12.26	17.82	17.70	34.36	33.94	54.21	54.13	101.78	5.17	0 – 4.572	0.457 – 4.115	2.29
8.89 / 350	7.97	9.55	11.17	14.44	14.32	20.81	20.67	40.12	39.63	63.27	63.21	118.80	6.04	0 – 5.334	0.533 – 4.801	2.67
10.16 / 400	9.12	10.92	12.78	16.52	16.38	23.80	23.63	45.88	45.31	72.33	72.30	135.82	6.91	0 – 6.096	0.610 – 5.486	3.05
12.70 / 500	11.41	13.67	16.00	20.68	20.49	29.78	29.57	57.39	56.68	90.45	90.47	169.87	8.66	0 – 7.620	0.762 – 6.858	3.81
15.24 / 600	13.71	16.42	19.21	24.83	24.61	35.76	35.51	68.91	68.05	108.58	108.64	203.91	10.40	0 – 9.144	0.914 – 8.230	4.57
17.78 / 700	16.00	19.17	22.43	28.99	28.72	41.74	41.45	80.42	79.41	126.70	126.81	-	12.15	0 – 10.668	1.067 – 9.601	5.33
20.32 / 800	18.30	21.92	25.65	33.15	32.84	47.72	47.38	91.93	90.78	144.82	144.98	-	13.90	0 – 12.192	1.219 – 10.973	6.10
22.86 / 900	20.59	24.66	28.86	37.31	36.95	53.70	53.32	103.45	102.15	162.95	163.15	-	15.64	0 – 13.716	1.372 – 12.344	6.86
25.40 / 1000	22.89	27.41	32.08	41.46	41.07	59.68	59.26	114.96	113.52	181.07	181.33	-	17.39	0 – 15.240	1.524 – 13.716	7.62

Unit: feet

Screen size (diagonal)	Distance to screen (L)												Height from the edge of screen to center of lens (H)			
	Zoom												Fixed-focus			
	ET-D75LE6 Zoom lens		ET-D75LE10 Zoom lens		ET-D75LE20 Zoom lens		ET-D75LE30 Zoom lens		ET-D75LE40 Zoom lens		ET-D75LE8 Zoom lens		ET-D75LE50 Fixed-focus lens	Zoom lenses Except ET-D75LE6		Fixed- focus lens
[m] / [in]	min.	max.	min.	max.	min.	max.	min.	max.	min.	max.	min.	max.				
1.78 / 70	5.1	6.1	7.1	9.2	9.2	13.4	13.3	25.9	25.6	41.1	40.5	77.0	3.8	0 – 3.5	0.4 – 3.1	1.8
2.03 / 80	5.8	7.0	8.2	10.6	10.5	15.3	15.2	29.6	29.3	47.0	46.4	88.2	4.4	0 – 4.0	0.4 – 3.6	2.0
2.29 / 90	6.6	7.9	9.2	11.9	11.9	17.3	17.2	33.4	33.0	53.0	52.4	99.3	4.9	0 – 4.5	0.4 – 4.0	2.3
2.54 / 100	7.3	8.8	10.3	13.3	13.2	19.2	19.1	37.2	36.8	58.9	58.3	110.5	5.5	0 – 5.0	0.5 – 4.5	2.5
3.05 / 120	8.9	10.6	12.4	16.0	15.9	23.2	23.0	44.8	44.2	70.8	70.3	132.9	6.6	0 – 6.0	0.6 – 5.4	3.0
3.81 / 150	11.1	13.3	15.6	20.1	20.0	29.0	28.8	56.1	55.4	88.6	88.2	166.4	8.4	0 – 7.5	0.8 – 6.7	3.8
5.08 / 200	14.9	17.8	20.8	26.9	26.7	38.8	38.6	75.0	74.1	118.4	118.0	222.2	11.2	0 – 10.0	1.0 – 9.0	5.0
6.35 / 250	18.6	22.3	26.1	33.7	33.5	48.7	48.3	93.9	92.7	148.1	147.8	278.1	14.1	0 – 12.5	1.3 – 11.3	6.3
7.62 / 300	22.4	26.8	31.4	40.6	40.2	58.5	58.1	112.7	111.4	177.9	177.6	333.9	17.0	0 – 15.0	1.5 – 13.5	7.5
8.89 / 350	26.1	31.3	36.6	47.4	47.0	68.3	67.8	131.6	130.0	207.6	207.4	389.8	19.8	0 – 17.5	1.7 – 15.8	8.8
10.16 / 400	29.9	35.8	41.9	54.2	53.7	78.1	77.5	150.5	148.7	237.3	237.2	445.6	22.7	0 – 20.0	2.0 – 18.0	10.0
12.70 / 500	37.4	44.8	52.5	67.8	67.2	97.7	97.0	188.3	186.0	296.8	296.8	557.3	28.4	0 – 25.0	2.5 – 22.5	12.5
15.24 / 600	45.0	53.9	63.0	81.5	80.7	117.3	116.5	226.1	223.3	356.2	356.4	669.0	34.1	0 – 30.0	3.0 – 27.0	15.0
17.78 / 700	52.5	62.9	73.6	95.1	94.2	136.9	136.0	263.8	260.5	415.7	416.0	-	39.9	0 – 35.0	3.5 – 31.5	17.5
20.32 / 800	60.0	71.9	84.2	108.8	107.7	156.6	155.4	301.6	297.8	475.1	475.7	-	45.6	0 – 40.0	4.0 – 36.0	20.0
22.86 / 900	67.6	80.9	94.7	122.4	121.2	176.2	174.9	339.4	335.1	534.6	535.3	-	51.3	0 – 45.0	4.5 – 40.5	22.5
25.40 / 1000	75.1	89.9	105.2	136.0	134.7	195.8	194.4	377.2	372.4	594.1	594.9	-	57.1	0 – 50.0	5.0 – 45.0	25.0

- The value for L (distance to screen) varies slightly within ±5% depending on the zoom lens characteristics.
- At the shortest projection distance, the zoom lens characteristics may cause slight image distortion.
- When vertical keystone correction is used, the image is corrected in the direction that reduces its projected size.

NOTE: When the ET-D75LE50 is mounted, the optical lens shift function cannot be used.

Calculation of the projection distance

For a screen size different from the above, use the equation below to calculate the projection distance.

Aspect ratio 16:10

Zoom lenses

ET-D75LE6	minimum	$L (m) = (\text{diagonal screen size in inches}) \times 0.02027 - 0.0566$
	maximum	$L (m) = (\text{diagonal screen size in inches}) \times 0.02428 - 0.0736$
ET-D75LE10	minimum	$L (m) = (\text{diagonal screen size in inches}) \times 0.02841 - 0.0857$
	maximum	$L (m) = (\text{diagonal screen size in inches}) \times 0.03672 - 0.1085$
ET-D75LE20	minimum	$L (m) = (\text{diagonal screen size in inches}) \times 0.03635 - 0.0832$
	maximum	$L (m) = (\text{diagonal screen size in inches}) \times 0.05282 - 0.1162$
ET-D75LE30	minimum	$L (m) = (\text{diagonal screen size in inches}) \times 0.05244 - 0.1131$
	maximum	$L (m) = (\text{diagonal screen size in inches}) \times 0.10171 - 0.1765$
ET-D75LE40	minimum	$L (m) = (\text{diagonal screen size in inches}) \times 0.10041 - 0.1577$
	maximum	$L (m) = (\text{diagonal screen size in inches}) \times 0.16009 - 0.1615$
ET-D75LE8	minimum	$L (m) = (\text{diagonal screen size in inches}) \times 0.16051 - 0.3862$
	maximum	$L (m) = (\text{diagonal screen size in inches}) \times 0.30074 - 0.3598$

Fixed-focus lens

ET-D75LE50	$L (m) = (\text{diagonal screen size in inches}) \times 0.01542 - 0.0713$
------------	---

Aspect ratio 16:9

Zoom lenses

ET-D75LE6	minimum	$L (m) = (\text{diagonal screen size in inches}) \times 0.02083 - 0.0566$
	maximum	$L (m) = (\text{diagonal screen size in inches}) \times 0.02495 - 0.0736$
ET-D75LE10	minimum	$L (m) = (\text{diagonal screen size in inches}) \times 0.02920 - 0.0857$
	maximum	$L (m) = (\text{diagonal screen size in inches}) \times 0.03774 - 0.1085$
ET-D75LE20	minimum	$L (m) = (\text{diagonal screen size in inches}) \times 0.03736 - 0.0832$
	maximum	$L (m) = (\text{diagonal screen size in inches}) \times 0.05429 - 0.1162$
ET-D75LE30	minimum	$L (m) = (\text{diagonal screen size in inches}) \times 0.05390 - 0.1131$
	maximum	$L (m) = (\text{diagonal screen size in inches}) \times 0.10453 - 0.1765$
ET-D75LE40	minimum	$L (m) = (\text{diagonal screen size in inches}) \times 0.10320 - 0.1577$
	maximum	$L (m) = (\text{diagonal screen size in inches}) \times 0.16454 - 0.1615$
ET-D75LE8	minimum	$L (m) = (\text{diagonal screen size in inches}) \times 0.16497 - 0.3862$
	maximum	$L (m) = (\text{diagonal screen size in inches}) \times 0.30910 - 0.3598$

Fixed-focus lens

ET-D75LE50	$L (m) = (\text{diagonal screen size in inches}) \times 0.01585 - 0.0713$
------------	---

Aspect ratio 4:3

Zoom lenses

ET-D75LE6	minimum	$L (m) = (\text{diagonal screen size in inches}) \times 0.02294 - 0.0566$
	maximum	$L (m) = (\text{diagonal screen size in inches}) \times 0.02749 - 0.0736$
ET-D75LE10	minimum	$L (m) = (\text{diagonal screen size in inches}) \times 0.03216 - 0.0857$
	maximum	$L (m) = (\text{diagonal screen size in inches}) \times 0.04157 - 0.1085$
ET-D75LE20	minimum	$L (m) = (\text{diagonal screen size in inches}) \times 0.04115 - 0.0832$
	maximum	$L (m) = (\text{diagonal screen size in inches}) \times 0.05980 - 0.1162$
ET-D75LE30	minimum	$L (m) = (\text{diagonal screen size in inches}) \times 0.05937 - 0.1131$
	maximum	$L (m) = (\text{diagonal screen size in inches}) \times 0.11514 - 0.1765$
ET-D75LE40	minimum	$L (m) = (\text{diagonal screen size in inches}) \times 0.11367 - 0.1577$
	maximum	$L (m) = (\text{diagonal screen size in inches}) \times 0.18123 - 0.1615$
ET-D75LE8	minimum	$L (m) = (\text{diagonal screen size in inches}) \times 0.18171 - 0.3862$
	maximum	$L (m) = (\text{diagonal screen size in inches}) \times 0.34046 - 0.3598$

Fixed-focus lens

ET-D75LE50	$L (m) = (\text{diagonal screen size in inches}) \times 0.01746 - 0.0713$
------------	---

• Distances calculated with the above equations will include slight deviations.

Shift range

Optical axis shift function allows to shift the position of a projected image as shown below.

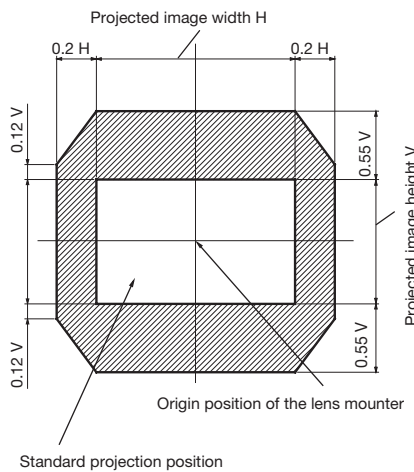
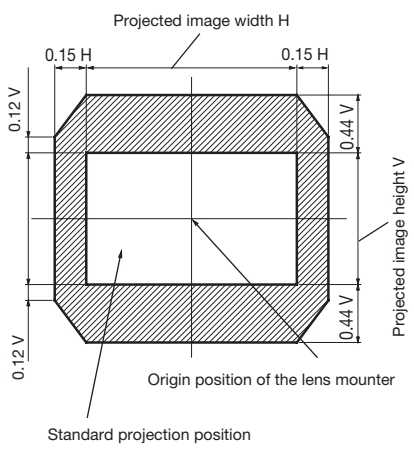
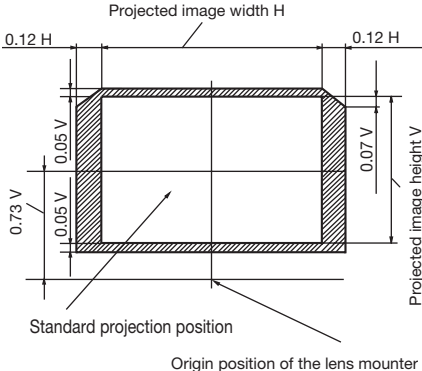
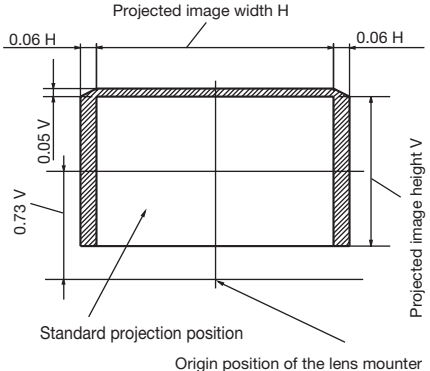
<p>Projection lens Model No.</p> <p>Lens shift range</p>	<p>ET-D75LE8, ET-D75LE10, ET-D75LE20, ET-D75LE30, ET-D75LE40</p> 	<p>ET-D75LE6</p> 
<p>Projection lens Model No.</p> <p>Lens shift range</p>	<p>ET-D75LE95</p> 	<p>ET-D75LE90</p> 

NOTE: Use the projection lens in the standard projection position without adjusting the lens shift when the optional Fixed-focus Lens (Model No. : ET-D75LE50) is attached.

Installable angle

Install the projector at an angle within the range shown below.

FULL 360-degree projection

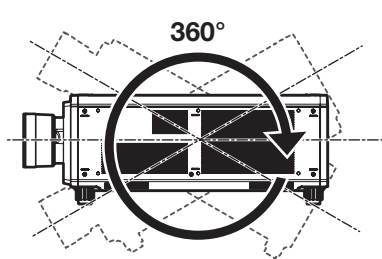

Vertical 360-deg.

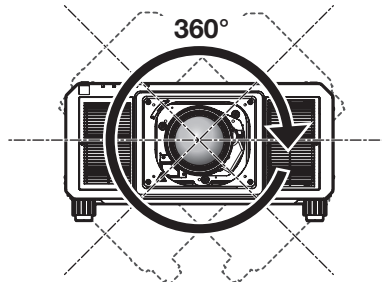

Horizontal 360-deg.

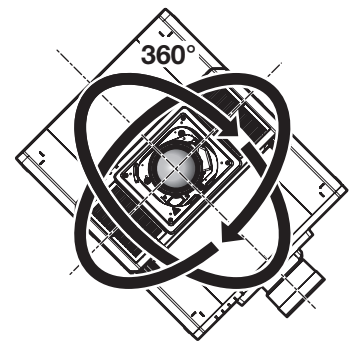

Tilting 360-deg.
(V&H combination)

Notes on projector placement and operation

- Prevent hot and cool air from the air conditioning system to blow directly to the ventilation ports (intake and exhaust) of the projector.

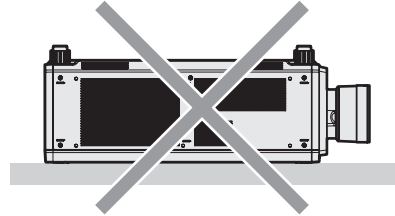
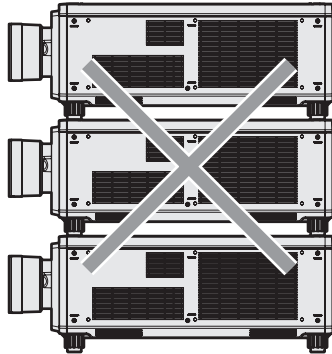

500 mm (19-11/16") or longer 500 mm (19-11/16") or longer

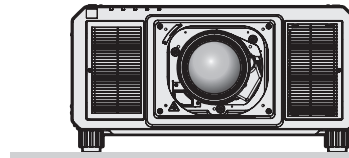
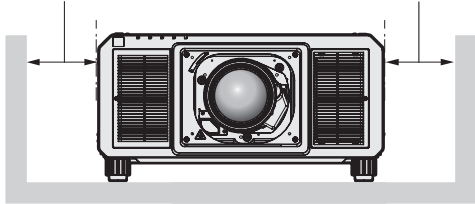

500 mm (19-11/16") or longer

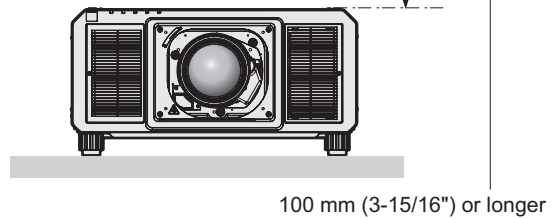
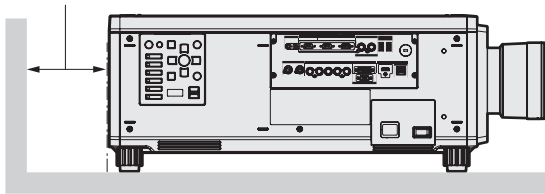

- Do not install the projector in a confined space. When installing the projector in a confined space, provide air conditioning or ventilation separately. Exhaust heat may accumulate when the ventilation is not enough, triggering the protection circuit of the projector.

List of compatible signals

The following table specifies the video signals compatible with the projector.

- Symbols that indicate formats are as follows.
 - V : VIDEO, Y/C
 - R: RGB (analog)
 - Y: YCbCr/YPbPr (analog)
 - D: DVI-D
 - H: HDMI
- Input corresponding to each item in the plug and play column is as follows.
 - RGB2: RGB2 input
 - DVI-D: DVI-D input
 - HDMI/DL: HDMI input, DIGITAL LINK input

Compatible signal	Resolution (Dots)	Scanning freq.		Dot clock freq. (MHz)	Format	RGB2	Plug and Play**			HDMI DL
		H (KHz)	V (Hz)				EDID1	DVD-D EDID2	EDID3	
NTSC/NTSC4.43/PAL-M/PAL60	720 × 480i	15.7	59.9	—	V	—	—	—	—	—
PAL/PAL-N/SECAM	720 × 576i	15.6	50.0	—	V	—	—	—	—	—
480/60i	720 × 480i	15.7	59.9	13.5	R/Y	—	—	—	—	—
576/50i	720 × 576i	15.6	50.0	13.5	R/Y	—	—	—	—	—
480/60i	720(1440) × 480i*2	15.7	59.9	27.0	D/H	—	—	—	—	—
576/50i	720(1440) × 576i*2	15.6	50.0	27.0	D/H	—	—	—	—	—
480/60p	720 × 480	31.5	59.9	27.0	R/Y/D/H	—	✓	—	✓	✓
576/50p	720 × 576	31.3	50.0	27.0	R/Y/D/H	—	✓	—	✓	✓
720/60p	1280 × 720	45.0	60.0	74.3	R/Y/D/H	—	✓	—	✓	✓
720/50p	1280 × 720	37.5	50.0	74.3	R/Y/D/H	—	✓	—	✓	✓
1080/60i	1920 × 1080i	33.8	60.0	74.3	R/Y/D/H	—	✓	—	✓	✓
1080/50i	1920 × 1080i	28.1	50.0	74.3	R/Y/D/H	—	✓	—	✓	✓
1080/24p	1920 × 1080	27.0	24.0	74.3	R/Y/D/H	—	✓	—	✓	✓
1080/24sF	1920 × 1080i	27.0	48.0	74.3	R/Y/D/H	—	—	—	—	—
1080/25p	1920 × 1080	28.1	25.0	74.3	R/Y/D/H	—	✓	—	✓	—
1080/30p	1920 × 1080	33.8	30.0	74.3	R/Y/D/H	—	—	—	—	—
1080/60p	1920 × 1080	67.5	60.0	148.5	R/Y/D/H	—	✓	—	✓	✓
1080/50p	1920 × 1080	56.3	50.0	148.5	R/Y/D/H	—	✓	—	✓	✓
640 × 400/70	640 × 400	31.5	70.1	25.2	R/D/H	—	—	—	—	—
640 × 400/85	640 × 400	37.9	85.1	31.5	R/D/H	—	—	—	—	—
640 × 480/60	640 × 480	31.5	59.9	25.2	R/D/H	✓	✓	✓	✓	✓
640 × 480/67	640 × 480	35.0	66.7	30.2	R/D/H	—	—	—	—	—
640 × 480/73	640 × 480	37.9	72.8	31.5	R/D/H	✓	—	✓	✓	✓
640 × 480/75	640 × 480	37.5	75.0	31.5	R/D/H	✓	—	✓	✓	✓
640 × 480/85	640 × 480	43.3	85.0	36.0	R/D/H	—	—	—	—	—
800 × 600/56	800 × 600	35.2	56.3	36.0	R/D/H	✓	—	✓	✓	✓
800 × 600/60	800 × 600	37.9	60.3	40.0	R/D/H	✓	—	✓	✓	✓
800 × 600/72	800 × 600	48.1	72.2	50.0	R/D/H	✓	—	✓	✓	✓
800 × 600/75	800 × 600	46.9	75.0	49.5	R/D/H	✓	—	✓	✓	✓
800 × 600/85	800 × 600	53.7	85.1	56.3	R/D/H	—	—	—	—	—
832 × 624/75	832 × 624	49.7	74.6	57.3	R/D/H	✓	—	✓	✓	✓
1024 × 768/50	1024 × 768	39.6	50.0	51.9	R/D/H	—	—	—	—	—
1024 × 768/60	1024 × 768	48.4	60.0	65.0	R/D/H	✓	—	✓	✓	✓
1024 × 768/70	1024 × 768	56.5	70.1	75.0	R/D/H	✓	—	✓	✓	✓
1024 × 768/75	1024 × 768	60.0	75.0	78.8	R/D/H	✓	—	✓	✓	✓
1024 × 768/82	1024 × 768	65.5	81.6	86.0	R/D/H	—	—	—	—	—
1024 × 768/85	1024 × 768	68.7	85.0	94.5	R/D/H	—	—	—	—	—
1024 × 768/100	1024 × 768*3	81.4	100.0	113.3	R/D/H	—	—	—	—	—
1024 × 768/120	1024 × 768*3	98.7	120.0	139.1	R/D/H	✓	—	✓	✓	✓
1152 × 864/60	1152 × 864	53.7	60.0	81.6	R/D/H	—	—	—	—	—
1152 × 864/70	1152 × 864	64.0	70.0	94.2	R/D/H	—	—	—	—	—
1152 × 864/75	1152 × 864	67.5	75.0	108.0	R/D/H	—	—	—	—	—
1152 × 864/85	1152 × 864	77.1	85.0	119.7	R/D/H	—	—	—	—	—
1152 × 870/75	1152 × 870	68.7	75.1	100.0	R/D/H	✓	—	✓	✓	✓
1280 × 720/50	1280 × 720	37.1	49.8	60.5	R/D/H	—	—	—	—	—
1280 × 720/60	1280 × 720	44.8	59.9	74.5	R/D/H	—	—	—	—	—
1280 × 720/100	1280 × 720*3	76.3	100.0	131.8	R/D/H	—	—	—	—	—
1280 × 720/120	1280 × 720*3	92.6	120.0	161.6	R/D/H	—	—	—	—	—

Compatible signal	Resolution (Dots)	Scanning freq.		Dot clock freq. (MHz)	Format	RGB2	Plug and Play*1			HDMI DL
		H (KHz)	V (Hz)				EDID1	DVD-D EDID2	EDID3	
1280 × 768/50	1280 × 768	39.6	49.9	65.3	R/D/H	—	—	—	—	—
1280 × 768/60	1280 × 768	47.8	59.9	79.5	R/D/H	—	—	—	—	—
	1280 × 768*4	47.4	60.0	68.3	R/D/H	—	—	—	—	—
1280 × 768/75	1280 × 768	60.3	74.9	102.3	R/D/H	—	—	—	—	—
1280 × 768/85	1280 × 768	68.6	84.8	117.5	R/D/H	—	—	—	—	—
1280 × 800/50	1280 × 800	41.3	50.0	68.0	R/D/H	—	—	—	—	—
1280 × 800/60	1280 × 800	49.7	59.8	83.5	R/D/H	—	—	—	—	—
	1280 × 800*4	49.3	59.9	71.0	R/D/H	—	—	—	—	—
1280 × 800/75	1280 × 800	62.8	74.9	106.5	R/D/H	—	—	—	—	—
1280 × 800/85	1280 × 800	71.6	84.9	122.5	R/D/H	—	—	—	—	—
1280 × 960/60	1280 × 960	60.0	60.0	108.0	R/D/H	—	—	—	—	—
1280 × 1024/50	1280 × 1024	52.4	50.0	88.0	R/D/H	—	—	—	—	—
1280 × 1024/60	1280 × 1024	64.0	60.0	108.0	R/D/H	—	—	—	—	—
1280 × 1024/66	1280 × 1024	72.3	66.3	125.0	R/D/H	—	—	—	—	—
1280 × 1024/72	1280 × 1024	78.2	72.0	135.1	R/D/H	—	—	—	—	—
1280 × 1024/75	1280 × 1024	80.0	75.0	135.0	R/D/H	✓	—	✓	✓	✓
1280 × 1024/85	1280 × 1024	91.1	85.0	157.5	R/D/H	—	—	—	—	—
1366 × 768/50	1366 × 768	39.6	49.9	69.0	R/D/H	—	—	—	—	—
1366 × 768/60	1366 × 768	47.7	59.8	85.5	R/D/H	—	—	—	—	—
1400 × 1050/50	1400 × 1050	54.1	50.0	99.9	R/D/H	—	—	—	—	—
	1400 × 1050	64.0	60.0	108.0	R/D/H	—	—	—	—	—
1400 × 1050/60	1400 × 1050	65.2	60.0	122.6	R/D/H	✓	—	✓	✓	✓
	1400 × 1050	65.3	60.0	121.8	R/D/H	—	—	—	—	—
	1400 × 1050	78.8	72.0	149.3	R/D/H	—	—	—	—	—
1400 × 1050/75	1400 × 1050	82.2	75.0	155.9	R/D/H	—	—	—	—	—
1440 × 900/50	1440 × 900	46.3	49.9	86.8	R/D/H	—	—	—	—	—
1440 × 900/60	1440 × 900	55.9	59.9	106.5	R/D/H	—	—	—	—	—
1600 × 900/50	1600 × 900	46.4	49.9	96.5	R/D/H	—	—	—	—	—
1600 × 900/60	1600 × 900	55.9	60.0	119.0	R/D/H	✓	—	✓	✓	✓
1600 × 1200/50	1600 × 1200	61.8	49.9	131.5	R/D/H	—	—	—	—	—
1600 × 1200/60	1600 × 1200	75.0	60.0	162.0	R/D/H	✓	—	✓	✓	✓
1680 × 1050/50	1680 × 1050	54.1	50.0	119.5	R/D/H	—	—	—	—	—
1680 × 1050/60	1680 × 1050	65.3	60.0	146.3	R/D/H	—	—	—	—	—
1920 × 1080/50	1920 × 1080	55.6	49.9	141.5	R/D/H	—	—	—	—	—
	1920 × 1080*4	66.6	59.9	138.5	R/D/H	—	—	—	—	—
1920 × 1080/60	1920 × 1080*5	67.2	60.0	173.0	R	—	—	—	—	—
	1920 × 1200/50	1920 × 1200	61.8	49.9	158.3	R/D/H	—	—	—	—
1920 × 1200/60	1920 × 1200*5	74.6	59.9	193.3	R	—	—	—	—	—
1920 × 1200/60RB	1920 × 1200*4	74.0	60.0	154.0	R/D/H	✓	—	✓	✓	✓

*1 Signal with ✓ in the plug and play column is a signal described in the EDID (extended display identification data) of the projector. The signal that does not have ✓ in the plug and play column can also be input if it is described in the format column. The resolution may not be selected in the computer even if the projector is compatible with the signal that does not have ✓ in the plug and play column.

*2 Pixel-Repetition signal (dot clock frequency 27.0 MHz) only

*3 Image is displayed as 3D image in the frame sequential format when [3D INPUT FORMAT] is set to [AUTO]. To display images in 2D, set [3D INPUT FORMAT] to [NATIVE].

*4 VESA CVT-RB (Reduced Blanking)-compliant.

*5 Image resolution is reduced by the image processing circuit before projection.

NOTE:

- A signal with a different resolution is converted to the number of display dots. The number of display dots is as follows. 1920 x 1200
- The “i” at the end of the resolution indicates an interlaced signal.
- When interlaced signals are connected, flickering may occur on the projected image.
- DIGITAL LINK input compatible signal is the same as HDMI input compatible signal.

List of SDI compatible signals

•Single link

Compatible signal	Resolution (Dots)	Scanning freq.		Dot clock freq. (MHz)	Format	Color space	Sampling
		H (KHz)	V (Hz)				
480/60i	720 × 480i	15.7	59.9	27.0	SD-SDI	YCbCr	4:2:2 10bit
576/50i	720 × 576i	15.6	50.0	27.0	SD-SDI	YCbCr	4:2:2 10bit
720/60p	1280 × 720	45.0	60.0*1	74.3	HD-SDI	YPbPr	4:2:2 10bit
720/50p	1280 × 720	37.5	50.0	74.3	HD-SDI	YPbPr	4:2:2 10bit

Compatible signal	Resolution (Dots)	Scanning freq.		Dot clock freq. (MHz)	Format	Color space	Sampling
		H (KHz)	V (Hz)				
1080/60i	1920 × 1080i	33.8	60.0*1	74.3	HD-SDI	YPbPr	4:2:2 10bit
	1920 × 1080i	33.8	60.0*1	74.3	3G-SDI Level-A	RGB	4:4:4 10bit
	1920 × 1080i	33.8	60.0*1	74.3	3G-SDI Level-B	RGB	4:4:4 10bit
	1920 × 1080i	33.8	60.0*1	74.3	3G-SDI Level-A	RGB	4:4:4 12bit
	1920 × 1080i	33.8	60.0*1	74.3	3G-SDI Level-B	RGB	4:4:4 12bit
1080/50i	1920 × 1080i	28.1	50.0	74.3	HD-SDI	YPbPr	4:2:2 10bit
	1920 × 1080i	28.1	50.0	74.3	3G-SDI Level-A	RGB	4:4:4 10bit
	1920 × 1080i	28.1	50.0	74.3	3G-SDI Level-B	RGB	4:4:4 10bit
	1920 × 1080i	28.1	50.0	74.3	3G-SDI Level-A	RGB	4:4:4 12bit
	1920 × 1080i	28.1	50.0	74.3	3G-SDI Level-B	RGB	4:4:4 12bit
1080/24p	1920 × 1080	27.0	24.0*1	74.3	HD-SDI	YPbPr	4:2:2 10bit
	1920 × 1080	27.0	24.0*1	74.3	3G-SDI Level-A	RGB	4:4:4 10bit
	1920 × 1080	27.0	24.0*1	74.3	3G-SDI Level-B	RGB	4:4:4 10bit
	1920 × 1080	27.0	24.0*1	74.3	3G-SDI Level-A	RGB	4:4:4 12bit
	1920 × 1080	27.0	24.0*1	74.3	3G-SDI Level-B	RGB	4:4:4 12bit
1080/24sF	1920 × 1080i	27.0	48.0*1	74.3	HD-SDI	YPbPr	4:2:2 10bit
	1920 × 1080i	27.0	48.0*1	74.3	3G-SDI Level-A	RGB	4:4:4 10bit
	1920 × 1080i	27.0	48.0*1	74.3	3G-SDI Level-B	RGB	4:4:4 10bit
	1920 × 1080i	27.0	48.0*1	74.3	3G-SDI Level-A	RGB	4:4:4 12bit
	1920 × 1080i	27.0	48.0*1	74.3	3G-SDI Level-B	RGB	4:4:4 12bit
1080/25p	1920 × 1080	28.1	25.0	74.3	HD-SDI	YPbPr	4:2:2 10bit
	1920 × 1080	28.1	25.0	74.3	3G-SDI Level-A	RGB	4:4:4 10bit
	1920 × 1080	28.1	25.0	74.3	3G-SDI Level-B	RGB	4:4:4 10bit
	1920 × 1080	28.1	25.0	74.3	3G-SDI Level-A	RGB	4:4:4 12bit
	1920 × 1080	28.1	25.0	74.3	3G-SDI Level-B	RGB	4:4:4 12bit
1080/30p	1920 × 1080	33.8	30.0*1	74.3	HD-SDI	YPbPr	4:2:2 10bit
	1920 × 1080	33.8	30.0*1	74.3	3G-SDI Level-A	RGB	4:4:4 10bit
	1920 × 1080	33.8	30.0*1	74.3	3G-SDI Level-B	RGB	4:4:4 10bit
	1920 × 1080	33.8	30.0*1	74.3	3G-SDI Level-A	RGB	4:4:4 12bit
	1920 × 1080	33.8	30.0*1	74.3	3G-SDI Level-B	RGB	4:4:4 12bit
1080/60p	1920 × 1080	67.5	60.0*1	148.5	3G-SDI Level-A	YPbPr	4:2:2 10bit
	1920 × 1080	67.5	60.0*1	148.5	3G-SDI Level-B	YPbPr	4:2:2 10bit
1080/50p	1920 × 1080	56.3	50.0	148.5	3G-SDI Level-A	YPbPr	4:2:2 10bit
	1920 × 1080	56.3	50.0	148.5	3G-SDI Level-B	YPbPr	4:2:2 10bit
2K/24p	2048 × 1080	27.0	24.0*1	74.3	3G-SDI Level-A	RGB	4:4:4 10bit
	2048 × 1080	27.0	24.0*1	74.3	3G-SDI Level-B	RGB	4:4:4 10bit
	2048 × 1080	27.0	24.0*1	74.3	3G-SDI Level-A	RGB	4:4:4 12bit
	2048 × 1080	27.0	24.0*1	74.3	3G-SDI Level-B	RGB	4:4:4 12bit
	2048 × 1080	27.0	24.0*1	74.3	3G-SDI Level-A	XYZ	4:4:4 12bit
	2048 × 1080	27.0	24.0*1	74.3	3G-SDI Level-B	XYZ	4:4:4 12bit
2K/25p	2048 × 1080	28.1	25.0	74.3	3G-SDI Level-A	RGB	4:4:4 10bit
	2048 × 1080	28.1	25.0	74.3	3G-SDI Level-B	RGB	4:4:4 10bit
	2048 × 1080	28.1	25.0	74.3	3G-SDI Level-A	RGB	4:4:4 12bit
	2048 × 1080	28.1	25.0	74.3	3G-SDI Level-B	RGB	4:4:4 12bit
	2048 × 1080	28.1	25.0	74.3	3G-SDI Level-A	XYZ	4:4:4 12bit
	2048 × 1080	28.1	25.0	74.3	3G-SDI Level-B	XYZ	4:4:4 12bit
2K/30p	2048 × 1080	33.8	30.0*1	74.3	3G-SDI Level-A	RGB	4:4:4 10bit
	2048 × 1080	33.8	30.0*1	74.3	3G-SDI Level-B	RGB	4:4:4 10bit
	2048 × 1080	33.8	30.0*1	74.3	3G-SDI Level-A	RGB	4:4:4 12bit
	2048 × 1080	33.8	30.0*1	74.3	3G-SDI Level-B	RGB	4:4:4 12bit
	2048 × 1080	33.8	30.0*1	74.3	3G-SDI Level-A	XYZ	4:4:4 12bit
	2048 × 1080	33.8	30.0*1	74.3	3G-SDI Level-B	XYZ	4:4:4 12bit
2K/48p	2048 × 1080	54.0	48.0*1	148.5	3G-SDI Level-A	YPbPr	4:2:2 10bit
	2048 × 1080	54.0	48.0*1	148.5	3G-SDI Level-B	YPbPr	4:2:2 10bit
2K/50p	2048 × 1080	56.3	50.0	148.5	3G-SDI Level-A	YPbPr	4:2:2 10bit
	2048 × 1080	56.3	50.0	148.5	3G-SDI Level-B	YPbPr	4:2:2 10bit
2K/60p	2048 × 1080	67.5	60.0*1	148.5	3G-SDI Level-A	YPbPr	4:2:2 10bit
	2048 × 1080	67.5	60.0*1	148.5	3G-SDI Level-B	YPbPr	4:2:2 10bit

*1 Compatible with VERTICAL SCAN FREQUENCY 1/1.001

List of SDI compatible signals

•Dual link

Compatible signal	Resolution (Dots)	Scanning freq.		Dot clock freq. (MHz)	Format	Color space	Sampling
		H (KHz)	V (Hz)				
1080/60i	1920 × 1080i	33.8	60.0*1	74.3	HD-SDI	RGB	4:4:4 10bit
	1920 × 1080i	33.8	60.0*1	74.3	HD-SDI	RGB	4:4:4 12bit
1080/50i	1920 × 1080i	28.1	50.0	74.3	HD-SDI	RGB	4:4:4 10bit
	1920 × 1080i	28.1	50.0	74.3	HD-SDI	RGB	4:4:4 12bit
1080/24p	1920 × 1080	27.0	24.0*1	74.3	HD-SDI	RGB	4:4:4 10bit
	1920 × 1080	27.0	24.0*1	74.3	HD-SDI	RGB	4:4:4 12bit
1080/24sF	1920 × 1080i	27.0	48.0*1	74.3	HD-SDI	RGB	4:4:4 10bit
	1920 × 1080i	27.0	48.0*1	74.3	HD-SDI	RGB	4:4:4 12bit
1080/25p	1920 × 1080	28.1	25.0	74.3	HD-SDI	RGB	4:4:4 10bit
	1920 × 1080	28.1	25.0	74.3	HD-SDI	RGB	4:4:4 12bit
1080/30p	1920 × 1080	33.8	30.0*1	74.3	HD-SDI	RGB	4:4:4 10bit
	1920 × 1080	33.8	30.0*1	74.3	HD-SDI	RGB	4:4:4 12bit
1080/60p	1920 × 1080	67.5	60.0*1	148.5	3G-SDI Level-A	YPbPr	4:4:4 10bit
	1920 × 1080	67.5	60.0*1	148.5	3G-SDI Level-B	YPbPr	4:4:4 10bit
	1920 × 1080	67.5	60.0*1	148.5	3G-SDI Level-A	YPbPr	4:4:4 12bit
	1920 × 1080	67.5	60.0*1	148.5	3G-SDI Level-B	YPbPr	4:4:4 12bit
	1920 × 1080	67.5	60.0*1	148.5	3G-SDI Level-A	RGB	4:4:4 10bit
	1920 × 1080	67.5	60.0*1	148.5	3G-SDI Level-B	RGB	4:4:4 10bit
	1920 × 1080	67.5	60.0*1	148.5	3G-SDI Level-A	RGB	4:4:4 12bit
	1920 × 1080	67.5	60.0*1	148.5	3G-SDI Level-B	RGB	4:4:4 12bit
	1920 × 1080	67.5	60.0*1	148.5	3G-SDI Level-A	RGB	4:4:4 12bit
	1920 × 1080	67.5	60.0*1	148.5	3G-SDI Level-B	RGB	4:4:4 12bit
1080/50p	1920 × 1080	56.3	50.0	148.5	3G-SDI Level-A	YPbPr	4:4:4 10bit
	1920 × 1080	56.3	50.0	148.5	3G-SDI Level-B	YPbPr	4:4:4 10bit
	1920 × 1080	56.3	50.0	148.5	3G-SDI Level-A	YPbPr	4:4:4 12bit
	1920 × 1080	56.3	50.0	148.5	3G-SDI Level-B	YPbPr	4:4:4 12bit
	1920 × 1080	56.3	50.0	148.5	3G-SDI Level-A	RGB	4:4:4 10bit
	1920 × 1080	56.3	50.0	148.5	3G-SDI Level-B	RGB	4:4:4 10bit
	1920 × 1080	56.3	50.0	148.5	3G-SDI Level-A	RGB	4:4:4 12bit
	1920 × 1080	56.3	50.0	148.5	3G-SDI Level-B	RGB	4:4:4 12bit
2K/24p	2048 × 1080	27.0	24.0*1	74.3	HD-SDI	RGB	4:4:4 10bit
	2048 × 1080	27.0	24.0*1	74.3	HD-SDI	RGB	4:4:4 12bit
	2048 × 1080	27.0	24.0*1	74.3	HD-SDI	XYZ	4:4:4 12bit
2K/48p	2048 × 1080	54.0	48.0*1	148.5	3G-SDI Level-A	YPbPr	4:4:4 10bit
	2048 × 1080	54.0	48.0*1	148.5	3G-SDI Level-B	YPbPr	4:4:4 10bit
	2048 × 1080	54.0	48.0*1	148.5	3G-SDI Level-A	YPbPr	4:4:4 12bit
	2048 × 1080	54.0	48.0*1	148.5	3G-SDI Level-B	YPbPr	4:4:4 12bit
	2048 × 1080	54.0	48.0*1	148.5	3G-SDI Level-A	RGB	4:4:4 10bit
	2048 × 1080	54.0	48.0*1	148.5	3G-SDI Level-B	RGB	4:4:4 10bit
	2048 × 1080	54.0	48.0*1	148.5	3G-SDI Level-A	RGB	4:4:4 12bit
	2048 × 1080	54.0	48.0*1	148.5	3G-SDI Level-B	RGB	4:4:4 12bit
2K/50p	2048 × 1080	56.3	50.0	148.5	3G-SDI Level-A	YPbPr	4:4:4 10bit
	2048 × 1080	56.3	50.0	148.5	3G-SDI Level-B	YPbPr	4:4:4 10bit
	2048 × 1080	56.3	50.0	148.5	3G-SDI Level-A	YPbPr	4:4:4 12bit
	2048 × 1080	56.3	50.0	148.5	3G-SDI Level-B	YPbPr	4:4:4 12bit
	2048 × 1080	56.3	50.0	148.5	3G-SDI Level-A	RGB	4:4:4 10bit
	2048 × 1080	56.3	50.0	148.5	3G-SDI Level-B	RGB	4:4:4 10bit
	2048 × 1080	56.3	50.0	148.5	3G-SDI Level-A	RGB	4:4:4 12bit
	2048 × 1080	56.3	50.0	148.5	3G-SDI Level-B	RGB	4:4:4 12bit
2K/60p	2048 × 1080	67.5	60.0*1	148.5	3G-SDI Level-A	YPbPr	4:4:4 10bit
	2048 × 1080	67.5	60.0*1	148.5	3G-SDI Level-B	YPbPr	4:4:4 10bit
	2048 × 1080	67.5	60.0*1	148.5	3G-SDI Level-A	YPbPr	4:4:4 12bit
	2048 × 1080	67.5	60.0*1	148.5	3G-SDI Level-B	YPbPr	4:4:4 12bit
	2048 × 1080	67.5	60.0*1	148.5	3G-SDI Level-A	RGB	4:4:4 10bit
	2048 × 1080	67.5	60.0*1	148.5	3G-SDI Level-B	RGB	4:4:4 10bit
	2048 × 1080	67.5	60.0*1	148.5	3G-SDI Level-A	RGB	4:4:4 12bit
	2048 × 1080	67.5	60.0*1	148.5	3G-SDI Level-B	RGB	4:4:4 12bit

*1 Compatible with VERTICAL SCAN FREQUENCY 1/1.001

List of simultaneous input 2D compatible signals

2D compatible signal	Resolution (Dots)	Scanning freq.		Dot clock freq. (MHz)	HDMI/DVI	SDI 1/SDI 2
		H (KHz)	V (Hz)			
1080/60p	1920 x 1080	67.5	60.0	148.5	✓	✓
1080/50p	1920 x 1080	56.3	50.0	148.5	✓	✓
1366 x 768/50	1366 x 768	39.6	49.9	69.0	✓	-
1366 x 768/60	1366 x 768	47.7	59.8	85.5	✓	-
1400 x 1050/50	1400 x 1050	54.1	50.0	99.9	✓	-
1400 x 1050/60	1400 x 1050	65.3	60.0	121.8	✓	-
1920 x 1080/50	1920 x 1080	55.6	49.9	141.5	✓	-
1920 x 1080/60	1920 x 1080	66.6	59.9	138.5	✓	-
1920 x 1200/50	1920 x 1200	61.8	49.9	158.3	✓	-
1920 x 1200/60	1920 x 1200	74.0	60.0	154.0	✓	-

List of compatible 3D signals

FP: Frame packing format 3G: 3G-SDI Level B simultaneous format
 SBS: Side by side format H-D: HDMI & DVI-D input simultaneous format
 TB: Top and bottom format R1-2: RGB1 & RGB2 input simultaneous format
 LBL: Line by line format S1-2: SDI1 & SDI2 input simultaneous format
 FS: Frame sequential format

3D Compatible signal	Resolution (Dots)	Scanning freq.		Dot clock freq. (MHz)	HDMI				DVI				RGB1/RGB2				SDI1/SDI2				H-D	R1-2	S1-2	
		H (KHz)	V (Hz)		FP	SBS*1	TB	FS	SBS*1	TB	LBL	FS	SBS*1	TB	LBL	FS	SBS*1	TB	LBL	3G				
720/60p	1280 x 720	45.0	60.0	74.3	✓	✓	✓	-	✓	✓	✓	-	✓	✓	✓	-	✓	✓	✓	✓	✓	✓	✓	✓
720/50p	1280 x 720	37.5	50.0	74.3	✓	✓	✓	-	✓	✓	✓	-	✓	✓	✓	-	✓	✓	✓	✓	✓	✓	✓	✓
1080/60i	1920 x 1080i	33.8	60.0	74.3	✓	✓	-	-	✓	✓	-	-	✓	✓	-	-	✓	✓	-	✓	✓	✓	✓	✓
1080/50i	1920 x 1080i	28.1	50.0	74.3	✓	✓	-	-	✓	✓	-	-	✓	✓	-	-	✓	✓	-	✓	✓	✓	✓	✓
1080/24p	1920 x 1080	27.0	24.0	74.3	✓	✓	✓	-	✓	✓	-	-	✓	✓	-	-	✓	✓	-	✓	✓	✓	✓	✓
1080/24sF	1920 x 1080i	27.0	24.0	74.3	-	-	-	-	✓	✓	-	-	✓	✓	-	-	✓	✓	-	✓	✓	✓	✓	✓
1080/25p	1920 x 1080	28.1	25.0	74.3	-	-	-	-	✓	✓	-	-	✓	✓	-	-	✓	✓	-	✓	✓	✓	✓	✓
1080/30p	1920 x 1080	33.8	30.0	74.3	-	-	-	-	✓	✓	-	-	✓	✓	-	-	✓	✓	-	✓	✓	✓	✓	✓
1080/60p	1920 x 1080	67.5	60.0	148.5	-	✓	✓	-	✓	✓	-	-	✓	✓	-	-	✓	✓	-	✓	✓	✓	✓	✓
1080/50p	1920 x 1080	56.3	50.0	148.5	-	✓	✓	-	✓	✓	-	-	✓	✓	-	-	✓	✓	-	✓	✓	✓	✓	✓
640 x 480	640 x 480	31.5	59.9	25.2	-	-	-	-	✓	-	-	-	✓	-	-	-	-	-	-	-	-	-	-	-
800 x 600	640 x 480	37.9	60.3	40.0	-	-	-	-	✓	-	-	-	✓	-	-	-	-	-	-	-	-	-	-	-
1024 x 768	1024 x 768	39.6	50.0	51.9	-	-	-	-	✓	-	-	-	✓	-	-	-	-	-	-	-	-	-	-	-
	1024 x 768	48.4	60.0	65.0	-	-	-	-	✓	-	-	-	✓	-	-	-	-	-	-	-	-	-	-	-
	1024 x 768	81.4	100.0	113.3	-	-	-	✓	-	-	-	✓	-	-	-	✓	-	-	-	-	-	-	-	-
	1024 x 768	98.8	120.0	139.1	-	-	-	✓	-	-	-	✓	-	-	-	✓	-	-	-	-	-	-	-	-
1152 x 864	1152 x 864	53.7	60.0	81.6	-	-	-	-	✓	-	-	-	✓	-	-	-	-	-	-	-	-	-	-	-
1280 x 720	1280 x 720	37.1	49.8	60.5	-	-	-	-	✓	-	-	-	✓	-	-	-	-	-	-	-	-	-	-	-
	1280 x 720	44.8	59.9	74.5	-	-	-	-	✓	-	-	-	✓	-	-	-	-	-	-	-	-	-	-	-
	1280 x 720	76.3	100.0	131.8	-	-	-	✓	-	-	-	✓	-	-	-	✓	-	-	-	-	-	-	-	-
	1280 x 720	92.6	120.0	161.6	-	-	-	✓	-	-	-	✓	-	-	-	✓	-	-	-	-	-	-	-	-
1280 x 768	1280 x 768	39.6	49.9	65.3	-	-	-	-	✓	-	-	-	✓	-	-	-	-	-	-	-	-	-	-	-
	1280 x 768	47.8	59.9	79.5	-	-	-	-	✓	-	-	-	✓	-	-	-	-	-	-	-	-	-	-	-
	1280 x 768*2	47.4	60.0	68.3	-	-	-	-	✓	-	-	-	✓	-	-	-	-	-	-	-	-	-	-	-
1280 x 800	1280 x 800	41.3	50.0	68.0	-	-	-	-	✓	-	-	-	✓	-	-	-	-	-	-	-	-	-	-	-
	1280 x 800	49.7	59.8	83.5	-	-	-	-	✓	-	-	-	✓	-	-	-	-	-	-	-	-	-	-	-
	1280 x 800*2	49.3	59.9	71.0	-	-	-	-	✓	-	-	-	✓	-	-	-	-	-	-	-	-	-	-	-
1280 x 960	1280 x 960	60.0	60.0	108.0	-	-	-	-	✓	-	-	-	✓	-	-	-	-	-	-	-	-	-	-	-
1280 x 1024	1280 x 1024	52.4	50.0	88.0	-	-	-	-	✓	-	-	-	✓	-	-	-	-	-	-	-	-	-	-	-
	1280 x 1024	64.0	60.0	108.0	-	-	-	-	✓	-	-	-	✓	-	-	-	-	-	-	-	-	-	-	-
1366 x 768	1366 x 768	47.7	59.8	85.5	-	-	-	-	✓	-	-	-	✓	-	-	-	-	-	-	-	-	-	-	-
	1366 x 768	39.6	49.9	69.0	-	-	-	-	✓	-	-	-	✓	-	-	-	-	-	-	-	-	-	-	-
1400 x 1050	1400 x 1050	54.1	50.0	99.9	-	-	-	-	✓	-	-	-	✓	-	-	-	-	-	-	-	-	-	✓	✓
	1400 x 1050	64.0	60.0	108.0	-	-	-	-	✓	-	-	-	✓	-	-	-	-	-	-	-	-	-	✓	✓
	1400 x 1050	65.2	60.0	122.6	-	-	-	-	✓	-	-	-	✓	-	-	-	-	-	-	-	-	-	✓	✓
	1400 x 1050	65.3	60.0	121.8	-	-	-	-	✓	-	-	-	✓	-	-	-	-	-	-	-	-	-	✓	✓

3D Compatible signal	Resolution (Dots)	Scanning freq.		Dot clock freq. (MHz)	HDMI				DVI				RGB1/RGB2				SDI1/SDI2				H-D	R1-2	S1-2	
		H (KHz)	V (Hz)		FP	SBS*1	TB	FS	SBS*1	TB	LBL	FS	SBS*1	TB	LBL	FS	SBS*1	TB	LBL	3G				
1440 x 900		55.9	59.9	106.5	-	-	-	-	✓	-	-	-	✓	-	-	-	-	-	-	-	-	-	-	-
		46.3	49.9	86.8	-	-	-	-	✓	-	-	-	✓	-	-	-	-	-	-	-	-	-	-	-
1600 x 900		46.4	49.9	96.5	-	-	-	-	✓	-	-	-	✓	-	-	-	-	-	-	-	-	-	-	-
		55.9	60.0	119.0	-	-	-	-	✓	-	-	-	✓	-	-	-	-	-	-	-	-	-	-	-
1600 x 1200		75.0	60.0	162.0	-	-	-	-	✓	-	-	-	✓	-	-	-	-	-	-	-	-	-	-	-
		61.8	49.9	131.5	-	-	-	-	✓	-	-	-	✓	-	-	-	-	-	-	-	-	-	-	-
1680 x 1050		65.3	60.0	146.3	-	-	-	-	✓	-	-	-	✓	-	-	-	-	-	-	-	-	-	-	-
		54.1	50.0	119.5	-	-	-	-	✓	-	-	-	✓	-	-	-	-	-	-	-	-	-	-	-
1920 x 1080		55.6	49.9	141.5	-	-	-	-	✓	-	-	-	✓	-	-	-	-	-	-	-	-	-	-	-
		66.6	59.9	138.5	-	-	-	-	✓	-	-	-	✓	-	-	-	-	-	-	-	-	-	-	-
1920 x 1200		61.8	49.9	158.3	-	-	-	-	✓	-	-	-	✓	-	-	-	-	-	-	-	-	-	✓	✓
		74.0	60.0	154.0	-	-	-	-	✓	-	✓	-	✓	-	✓	-	-	-	-	-	-	-	✓	✓

*1 Supports half.

*2 VESA CVT RB (Reduced Blanking) compliant

Note : DIGITAL LINK input compatible signal is the same as HDMI input compatible signal.